

NORTHGATE SE GIS Print Template

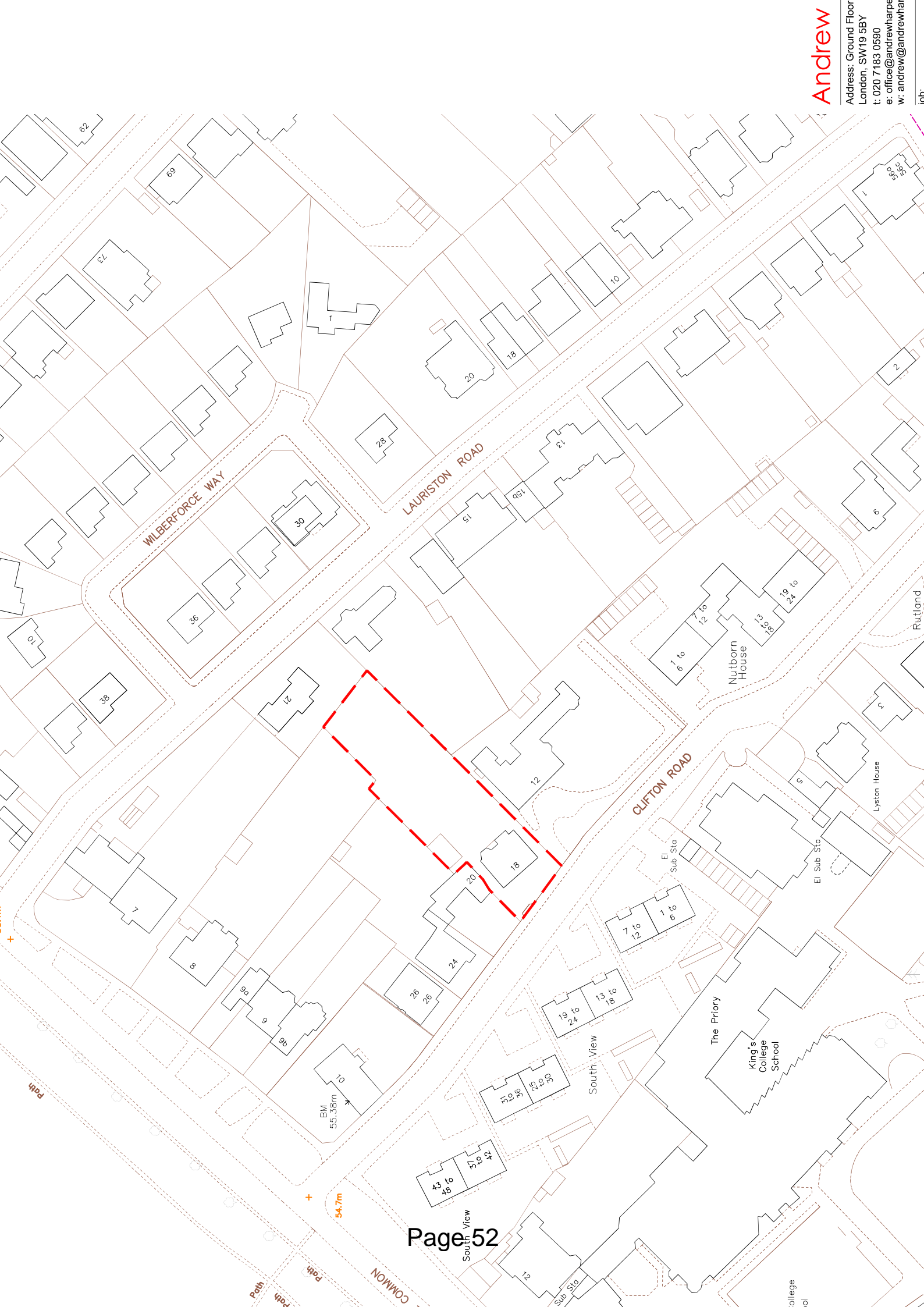

This material has been reproduced from Ordnance Survey digital map data with the permission of the controller of Her Majesty's Stationery Office, © Crown Copyright.

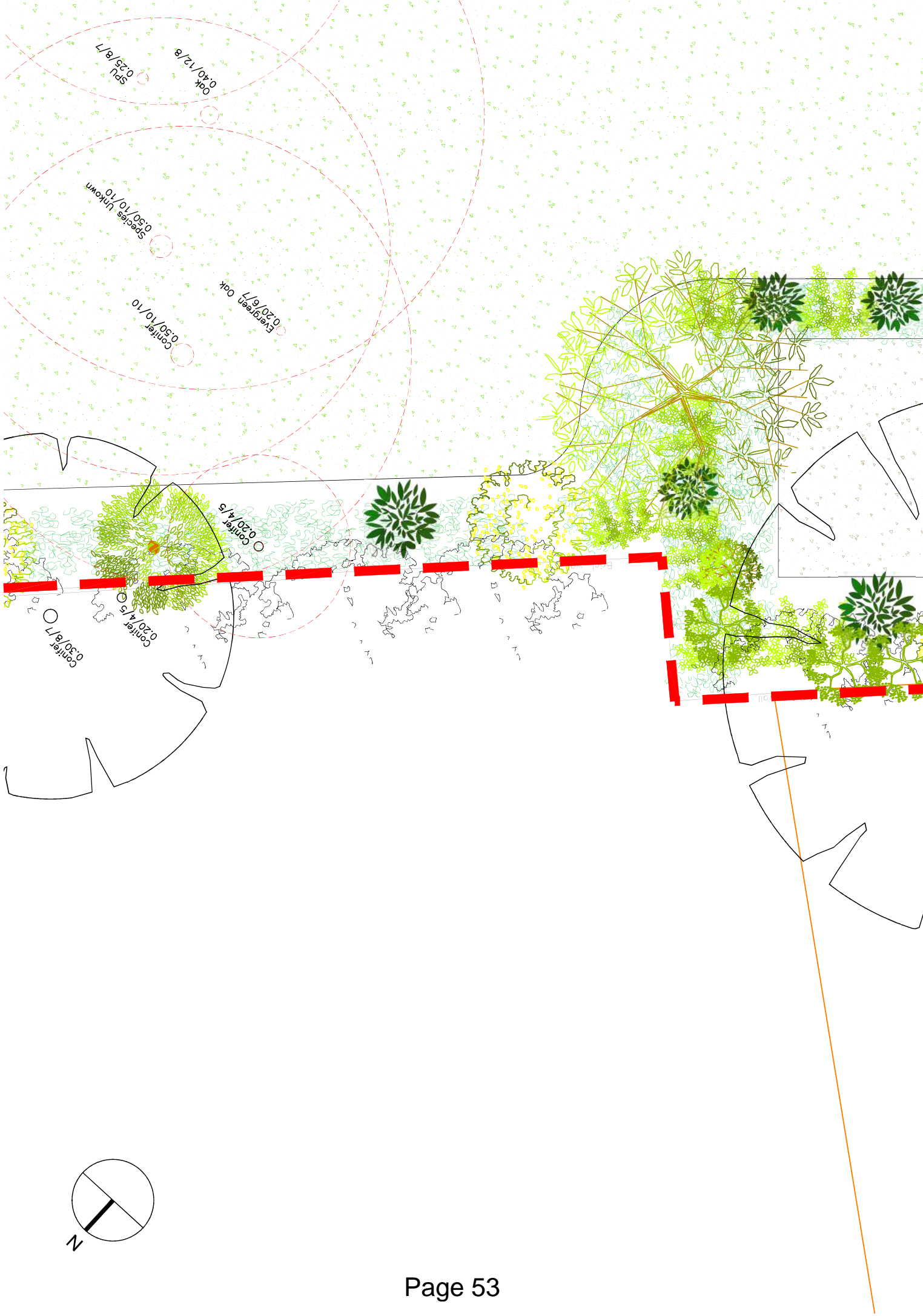

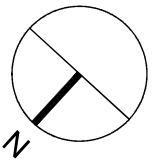

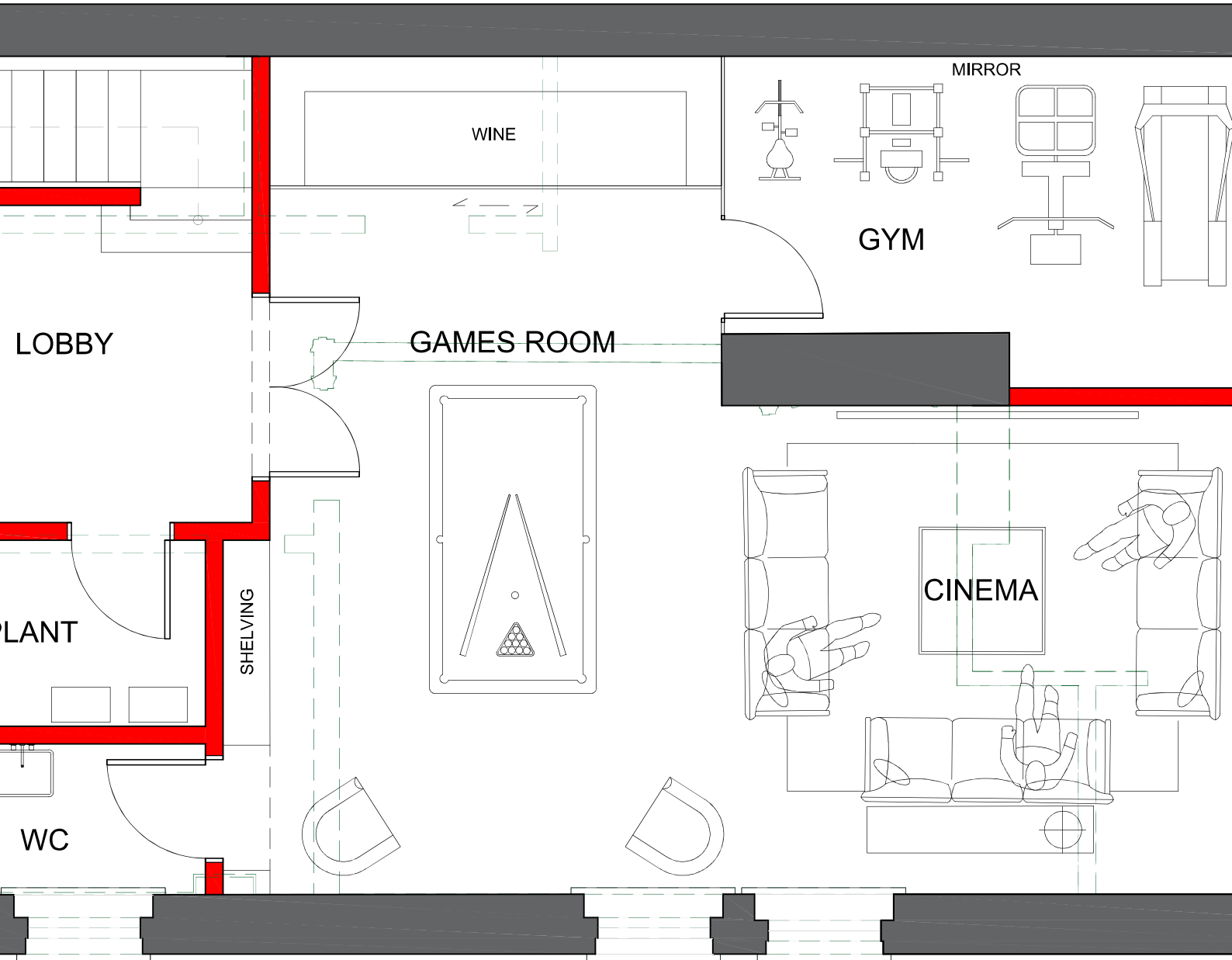

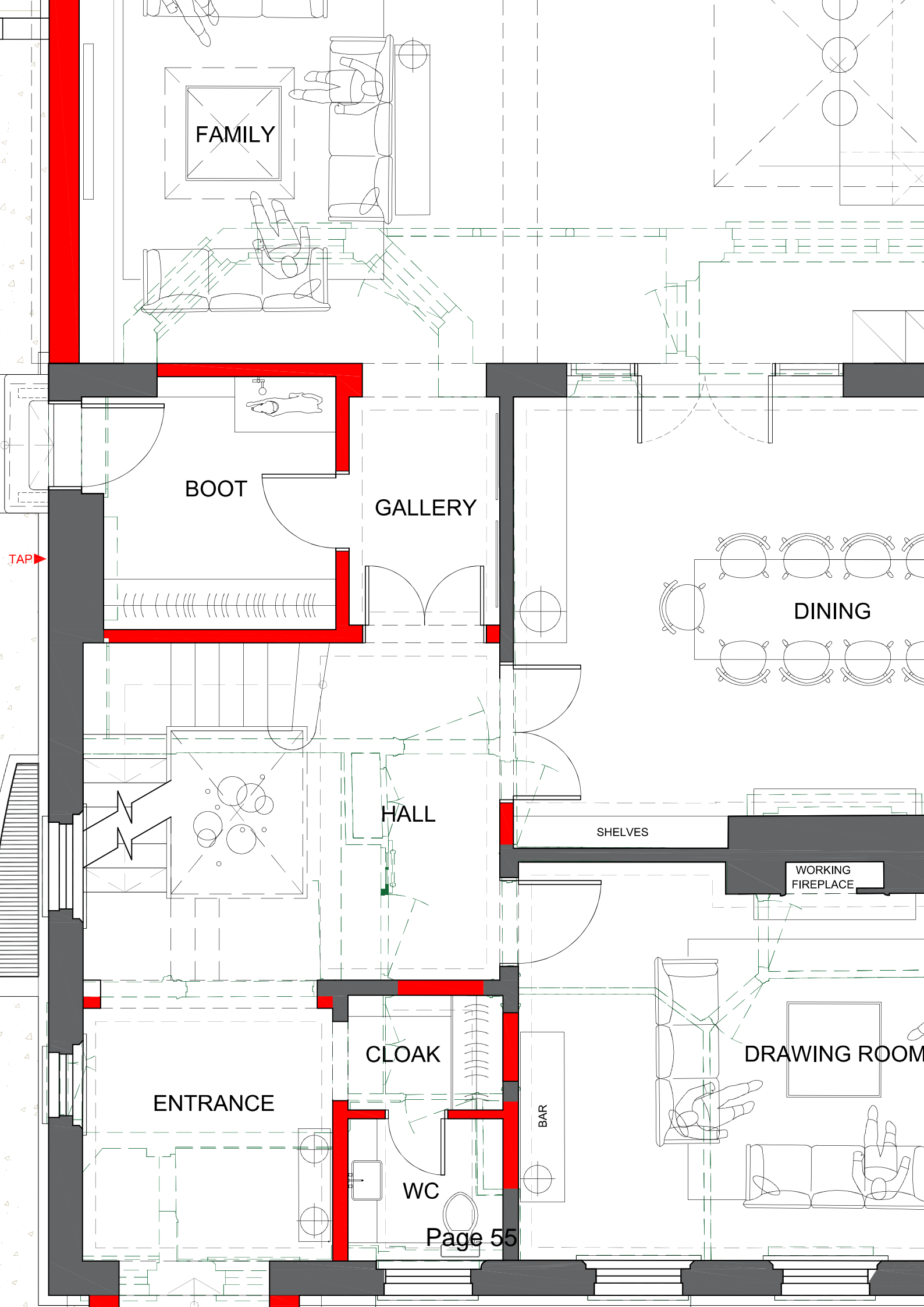

FAMILY

BOOT

GALLERY

DINING

HALL

SHELVES

WORKING
FIREPLACE

CLOAK

ENTRANCE

WC

BAR

DRAWING ROOM

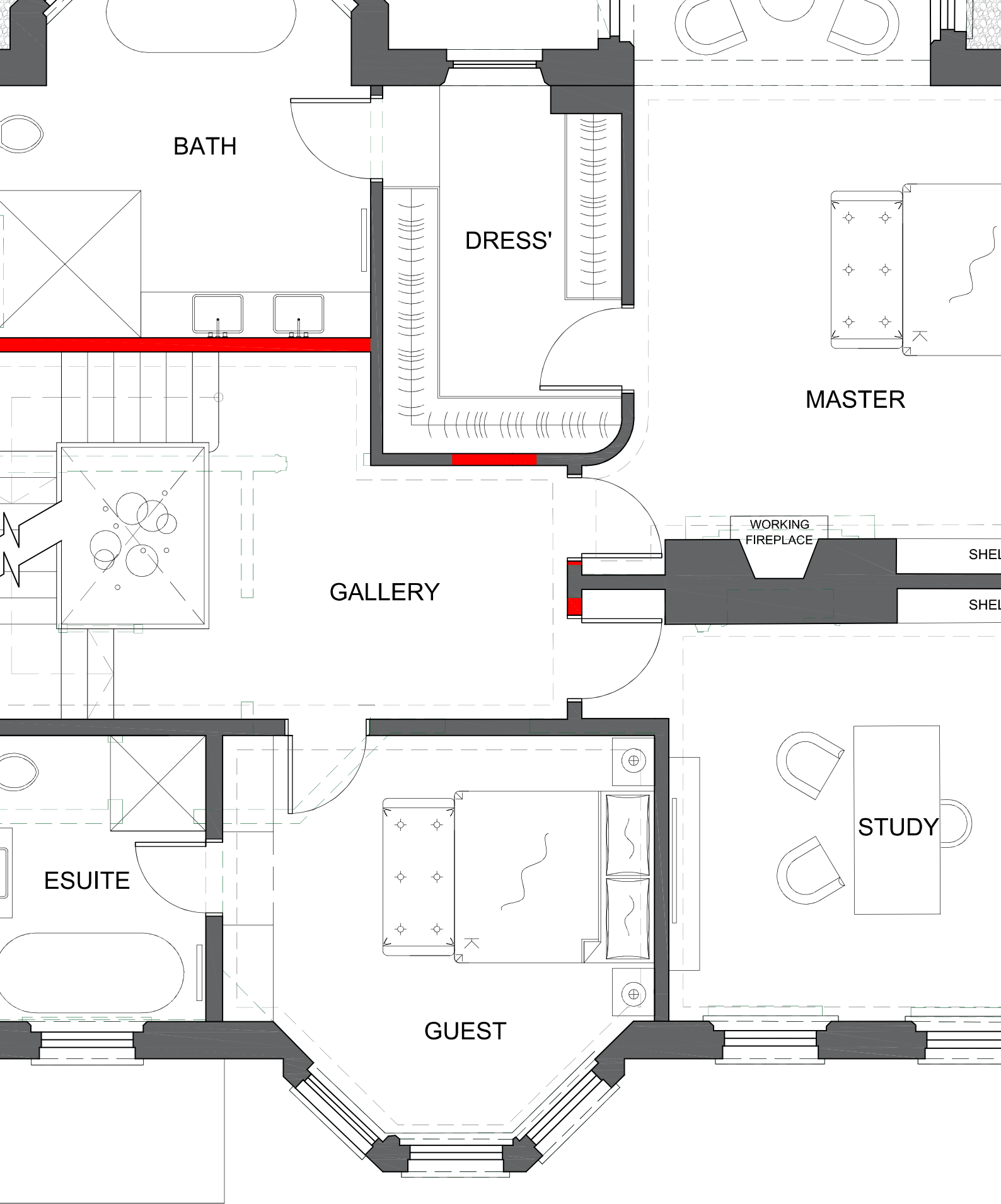

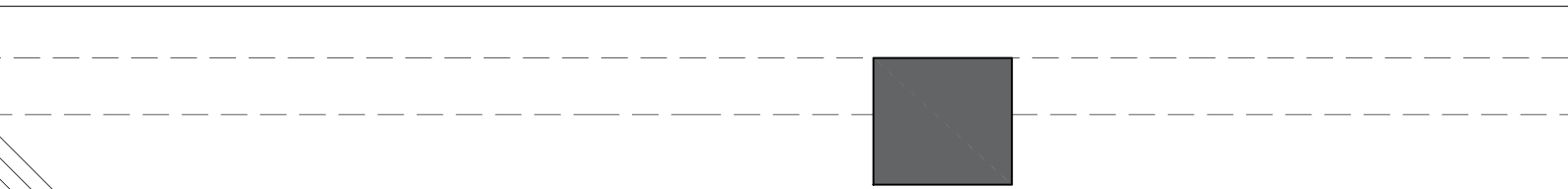
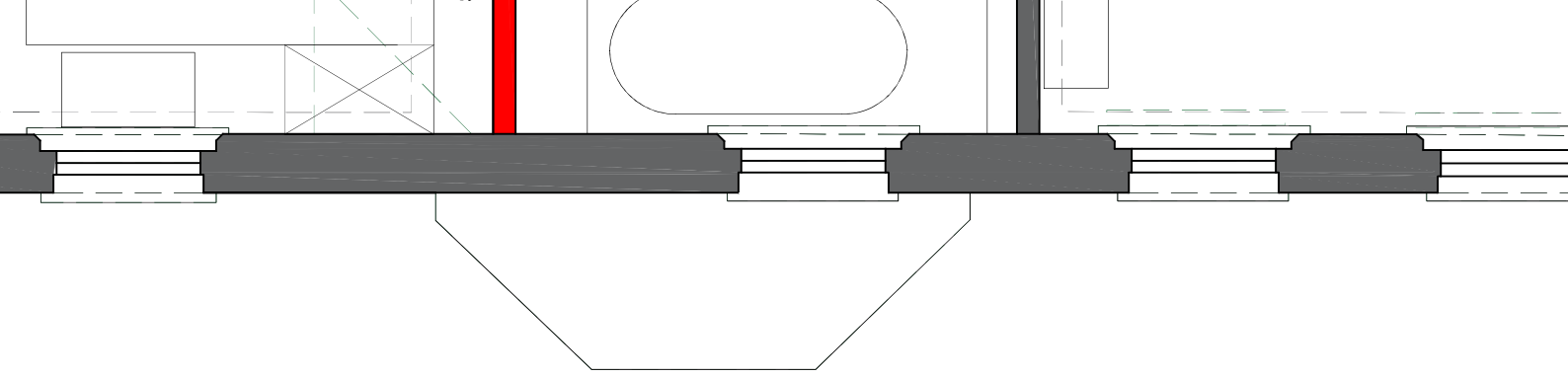

EAVES STORAGE

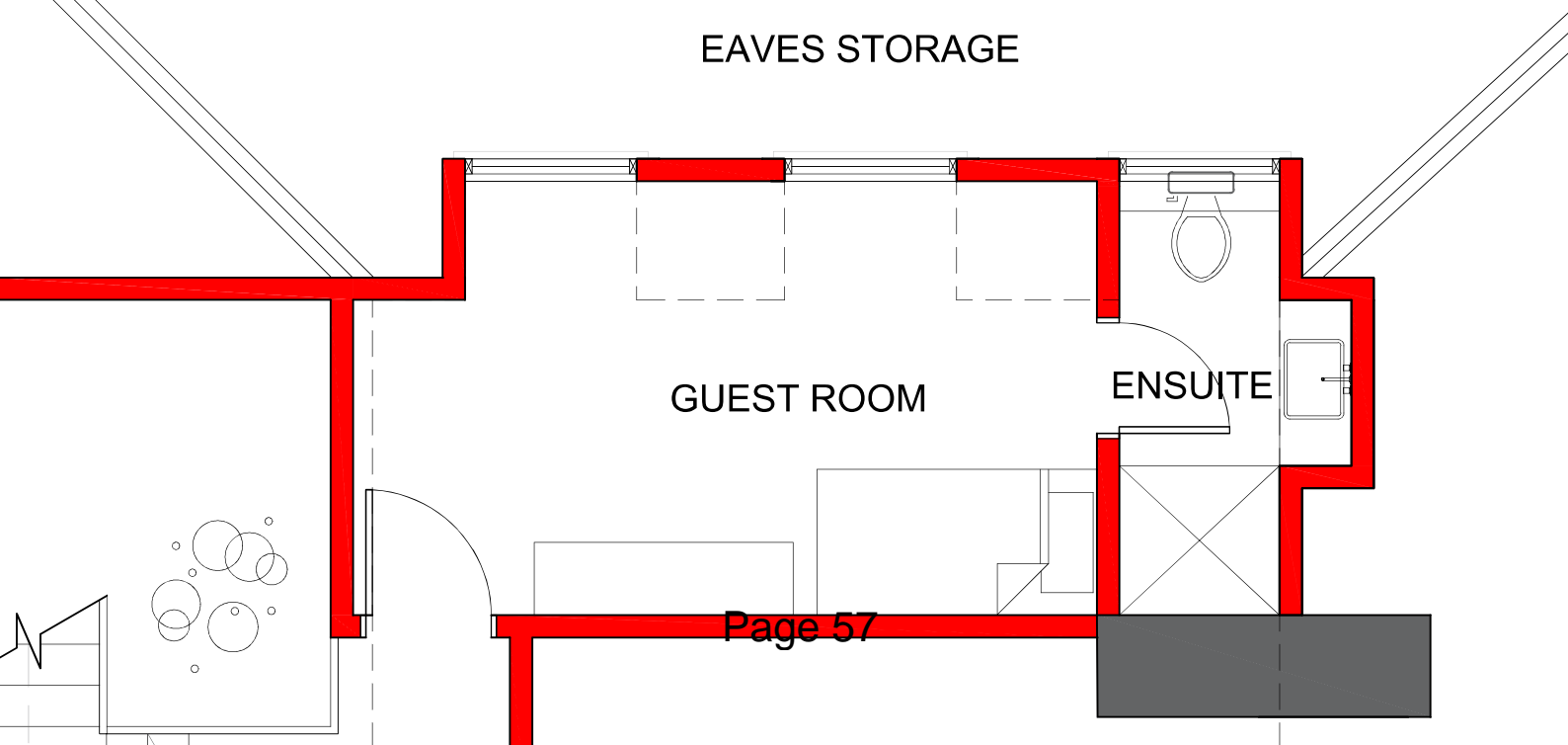

GUEST ROOM

ENSUITE



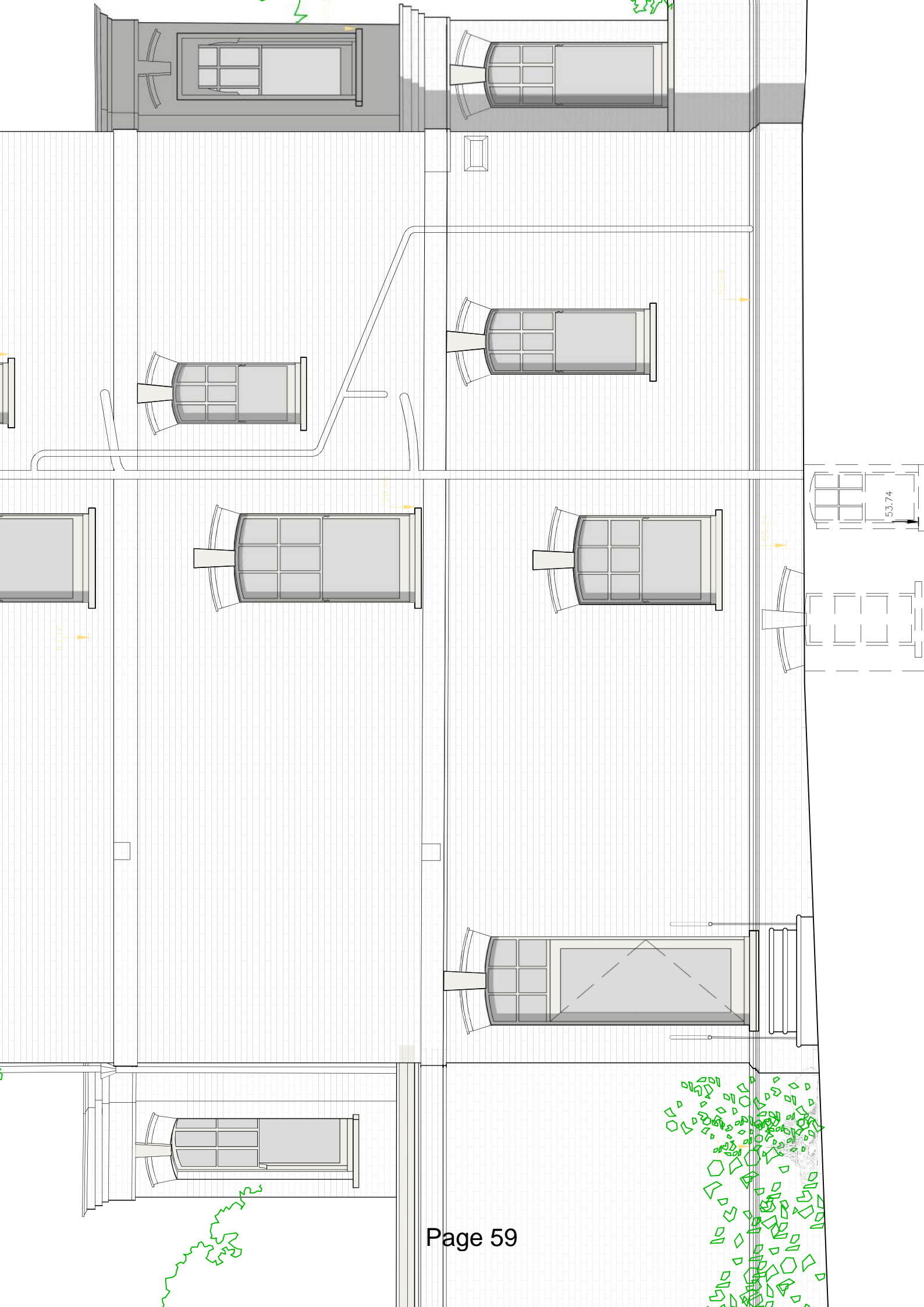



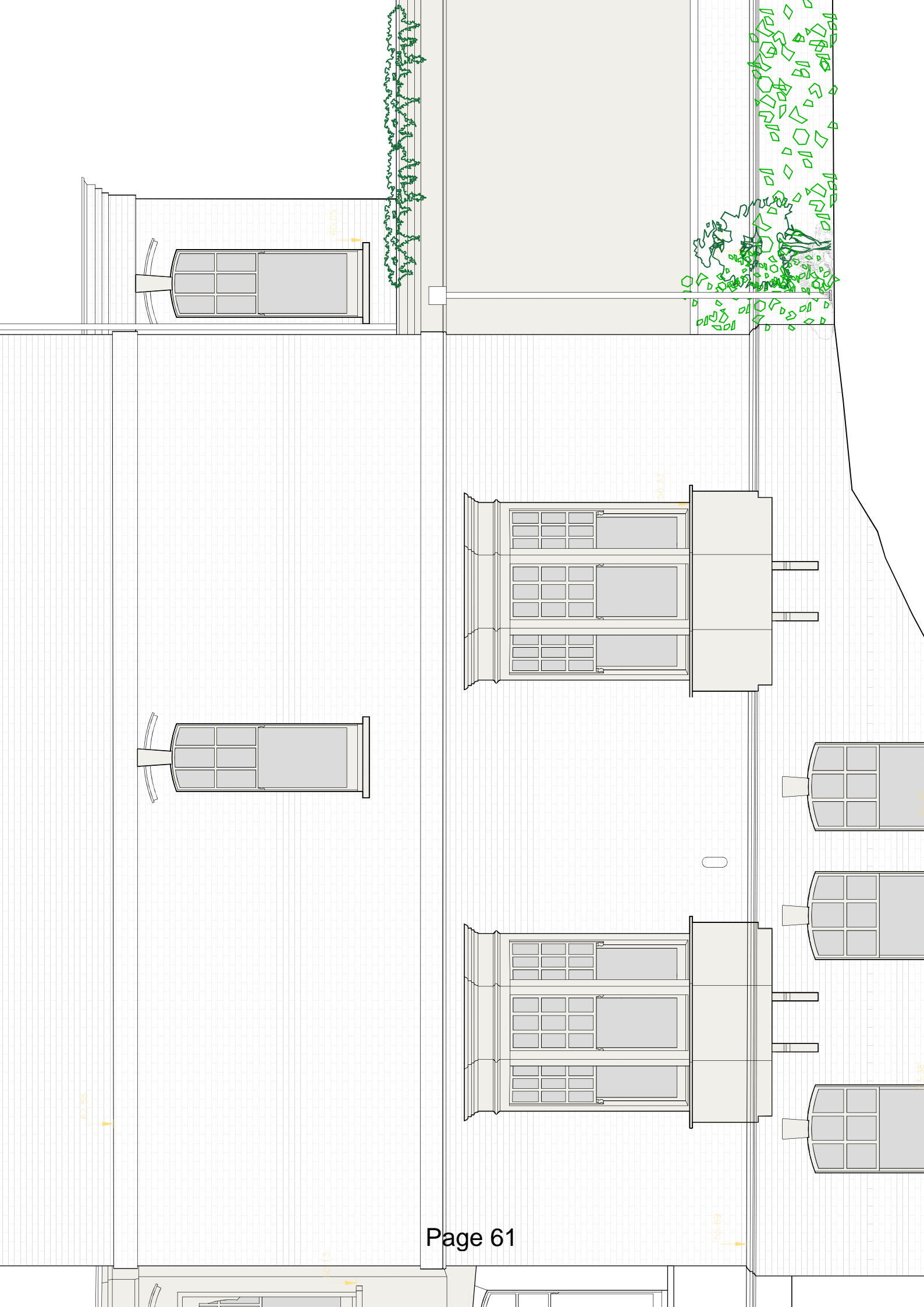

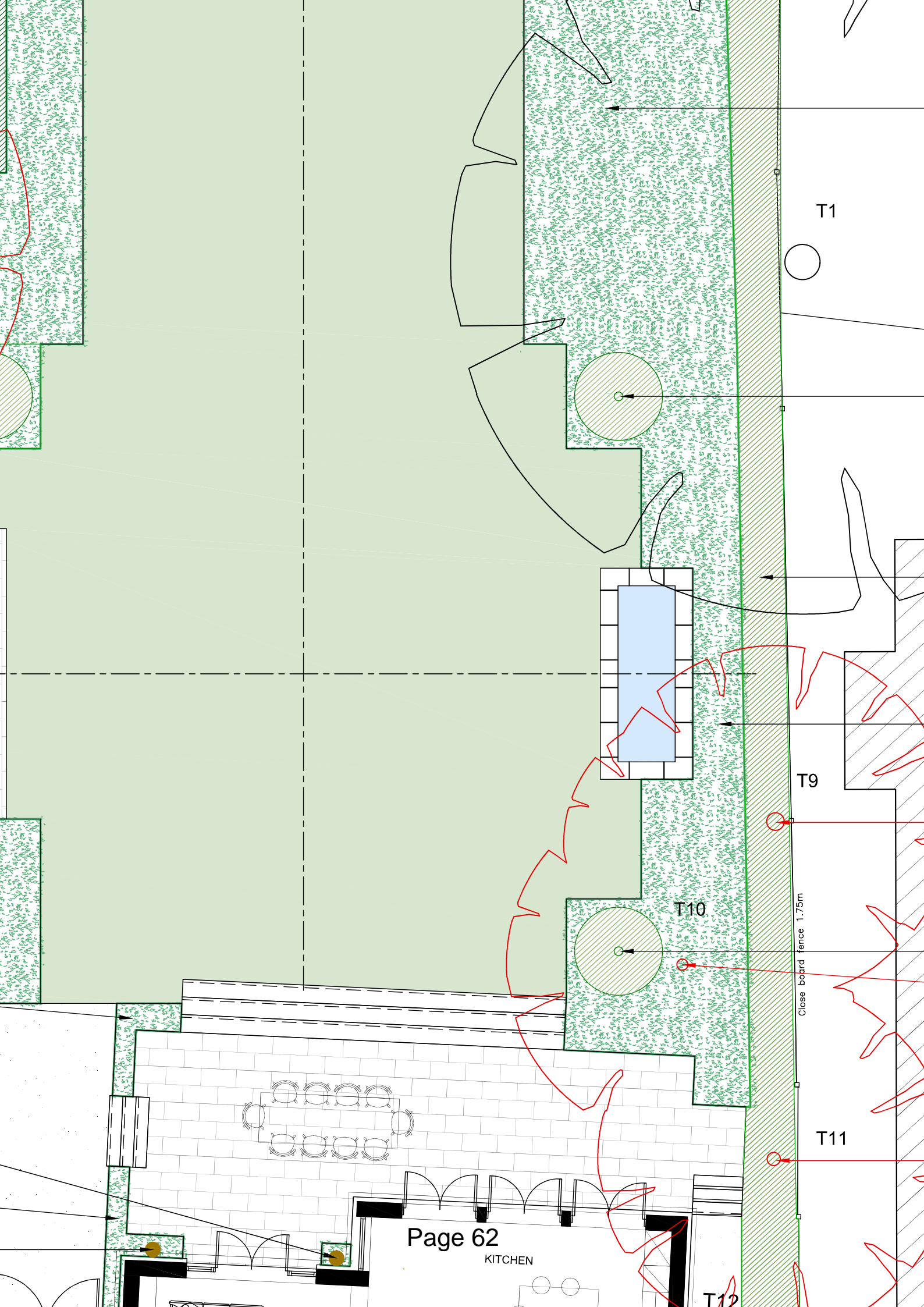

T1

T9

T10

T11

T12

Page 62

KITCHEN

Close board fence 1.75m

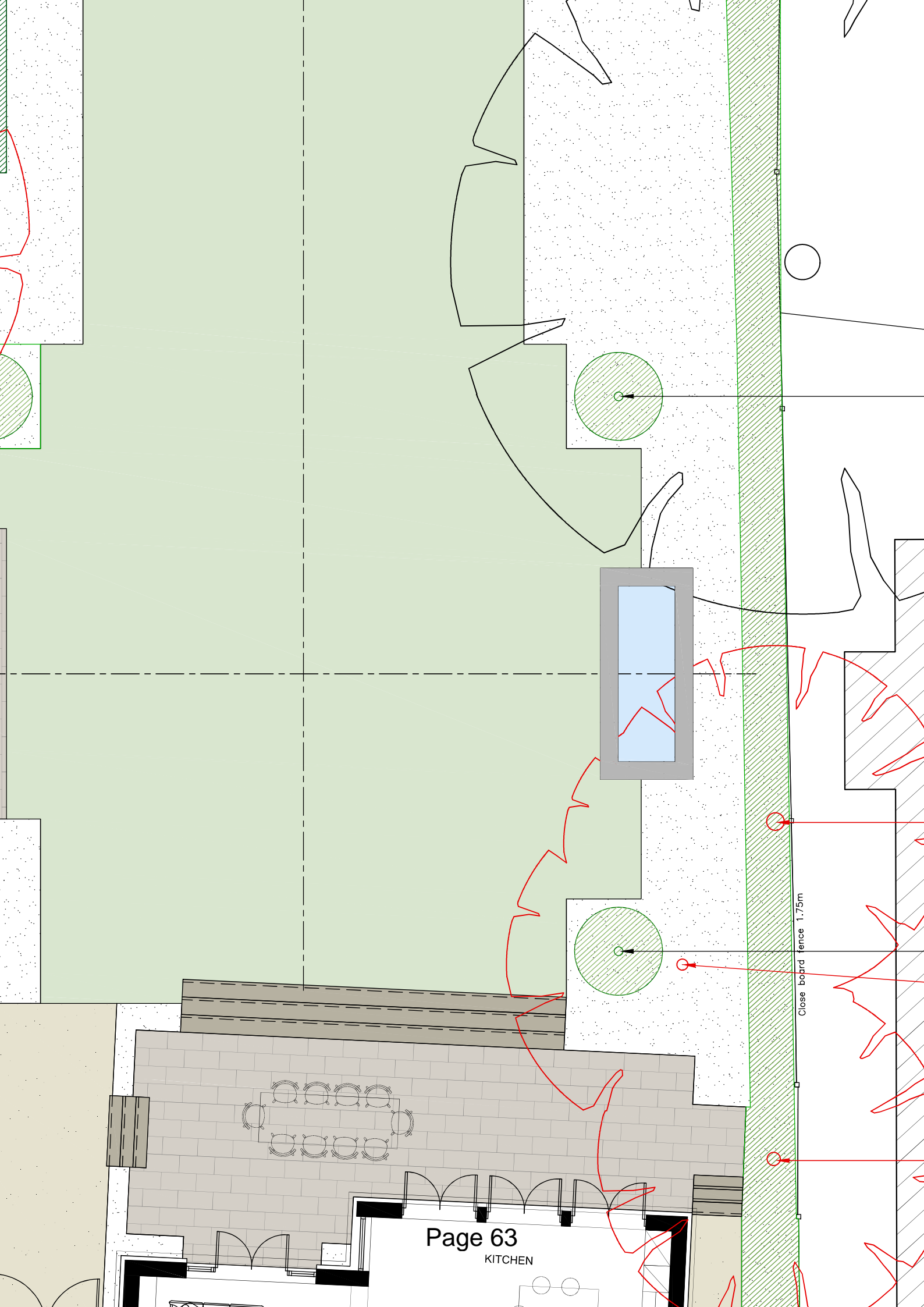

Page 63
KITCHEN

Close board fence 1.75m



ATION

